



High Power CW 532 nm DPSS Lasers Sprout-D Series



Features

- Compact laser head with Seal™ enclosure for long lifetime
- LockT™ optics mounting for permanent laser head alignment
- Long lifetime pump diode pack integrated inside laser head
- Low noise option <0.02% rms with Noise Elimination Technology
- Excellent long-term power stability <0.5% rms over 24 hours
- Bench-top, compact power supply with touch-screen control
- Disconnectable, 3 meter long control cable
- 5, 6, 8, 10, 12, 15, 18 and 20 W versions

Applications

- Pumping Ti:Sapphire lasers:
ultrafast & continuous-wave
- Pumping dye lasers
- Flow visualization, PIV
- Flow cytometry
- Spectroscopy

Patented

Sprout™ is a compact, diode-pumped solid-state (DPSS) laser providing high-power, continuous-wave (CW) power at 532nm in a near- perfect TEM₀₀ mode with extremely low optical noise and excellent long-term stability. Sprout™ is truly a next-generation laser designed and manufactured using many years of experience to provide a sealed, turn-key source of collimated green light with high spectral purity.

A number of key technologies enable Sprout™ to guarantee this performance. Seal™ technology keeps all dirt, dust and moisture out of the laser head to provide years of uninterrupted usage without need for cleaning or maintenance. LockT™ technology locks all laser head optics permanently in perfect alignment. Finally, for those applications requiring near-zero optical noise, Noise Elimination Technology (NET™) is the solution.

The laser head is a monolithic 3-dimensional design for ruggedness and compactness to minimize the space consumed in your lab or instrument. The pump diode package, integrated inside the laser head, has a typical mean time to failure (MTTF) of more than 50,000 hours to minimize cost-of-ownership. Locating the pump diode in the laser head rather than the power supply eliminates the fiber optic delivery cable.

A 3 meter long, flexible, disconnectable control cable connects the laser head to a compact power supply with touch-screen control. The power supply can sit next to the laser head or on an overhead shelf. Additional system features include automatic laser power control and USB, RS-232 and Ethernet interfaces for external monitoring, control and remote service.

Sprout™ is a state-of-the-art laser designed for today's integrated solutions. It combines superb performance and tremendous value for today's market.

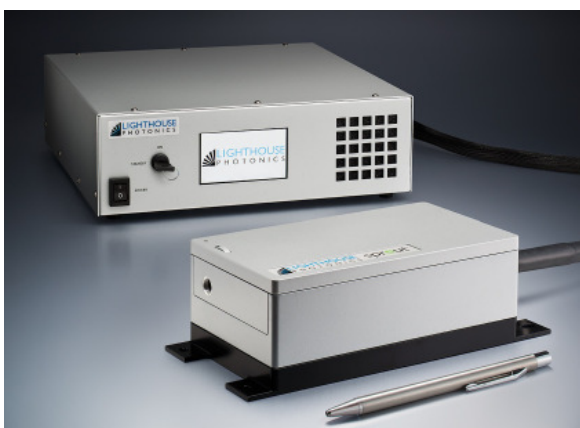



Laser Output Characteristics ^{1,9}	D-5W	D-6W	D-8W	D-10W	D-12W	D-15W	D-18W	D-20W
Average Output Power	> 5 W	> 6 W	> 8 W	> 10 W	> 12 W	> 15 W	> 18 W	> 20 W
Wavelength	532 nm							
Spectral Purity ²	> 99.9 %							
Spatial Mode	TEM ₀₀							
Beam Quality (M ²)	1.0 - 1.1							
Beam Ellipticity	< 1.0 : 1.1							
Beam Diameter ³	2.3 mm ± 10%							
Beam Divergence ⁴	< 0.5 mrad							
Pointing Stability ⁵	< 2 μrad/°C							
Power Stability ⁶	< ± 0.25 % rms							
Noise ⁷	Standard version: < 0.1 % rms Low noise (NET) version: < 0.02 % rms							
Polarization	> 100:1 vertical Horizontal polarization option available							
Power Requirements								
Operating Voltage	100-240 VAC, 50 Hz / 60 Hz							
Power Consumption	5W-12W versions: 300 W max, 200 W typical 15W-20W versions: 600 W max, 400 W typical							
Cooling Requirements								
Laser Head ⁸	5W-12W versions: 200 W heat removal capacity, water temperature 23°C ± 1°C 15W-20W versions: 400 W heat removal capacity, water temperature 23°C ± 1°C							
Power Supply	Air-cooled							
Environmental Specifications								
Operating Temperature	64-90°F (18-32°C)							
Relative Humidity	8-85%, non-condensing							
Laser Head - Physical								
Dimensions (Height x Width x Length)	5W-12W versions: 2.7 x 5.3 x 9.4 inches (69 x 135 x 240 mm) 15W-20W versions: 2.7 x 5.3 x 16.8 inches (69 x 135 x 425 mm)							
Weight	5W-12W versions: 9.2 lbs (4.2 kg) 15W-20W versions: 16.7 lbs (7.6 kg)							
Cable Length	10 ft (3 m) 16 ft (5 m) option available for 5W-12W versions							
Power Supply - Physical								
Dimensions (Height x Width x Depth)	4.7 x 13.9 x 14.1 inches (119 x 353 x 360 mm)							
Weight	26.0 lbs (11.8 kg), including cable							

Notes:

1. All performance specifications are guaranteed at specified power
2. Output power at 532 nm compared to output power at 1064 nm
3. 1/e², measured at the output port of the laser head
4. Full angle (1/e²), measured at the output port of the laser head
5. Measured at far-field x and y positions after a 30 minute warm-up and over a 20°C to 30°C temperature range
6. Measured over a 24 hour period after a 15 minute warm-up
7. Measured from 10 Hz to 10 MHz
8. Assuming an environmental temperature for laser head of 25°C or less
9. Lighthouse Photonics is continually improving the performance of its products. Specifications subject to change without notice.

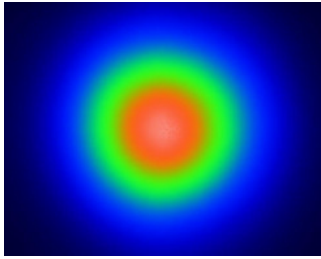

Typical Far-field beam profile

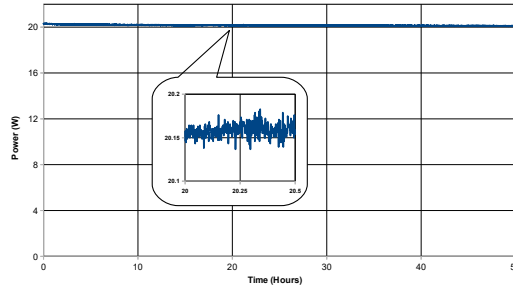

Power stability <0.1% rms over >24 hours

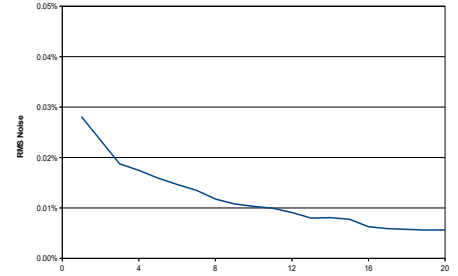

Optical noise <0.02% rms for NET™ version

Laser Head Dimensions

5W, 6W, 8W, 10W,
and 12W versions

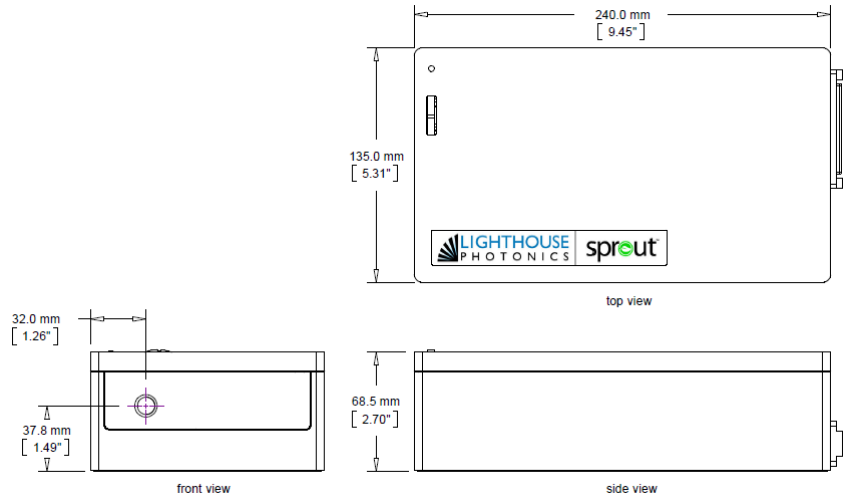

15W, 18W
and 20W versions

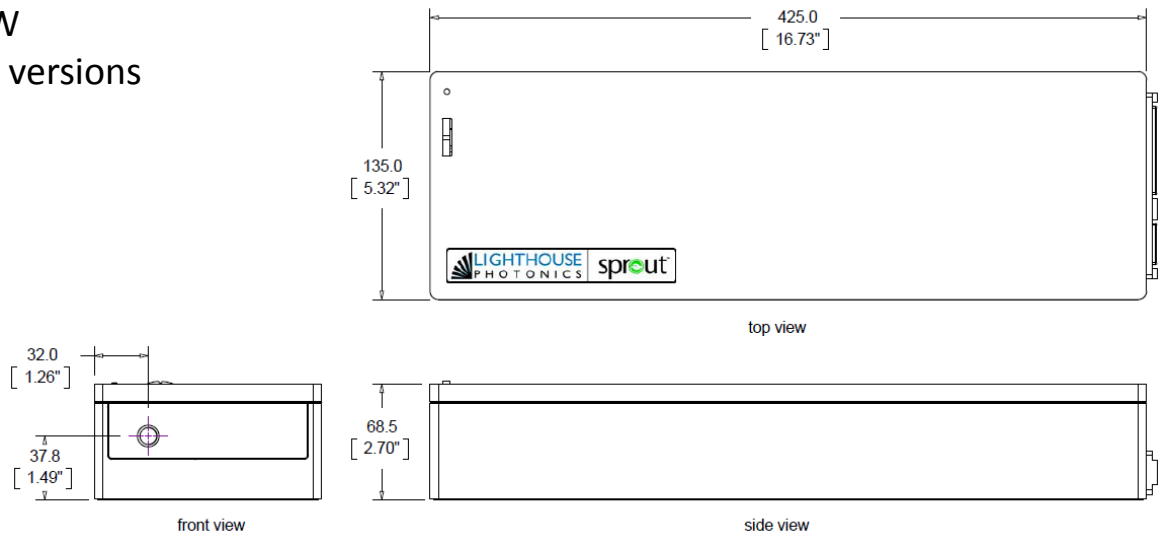

Power Supply Dimensions

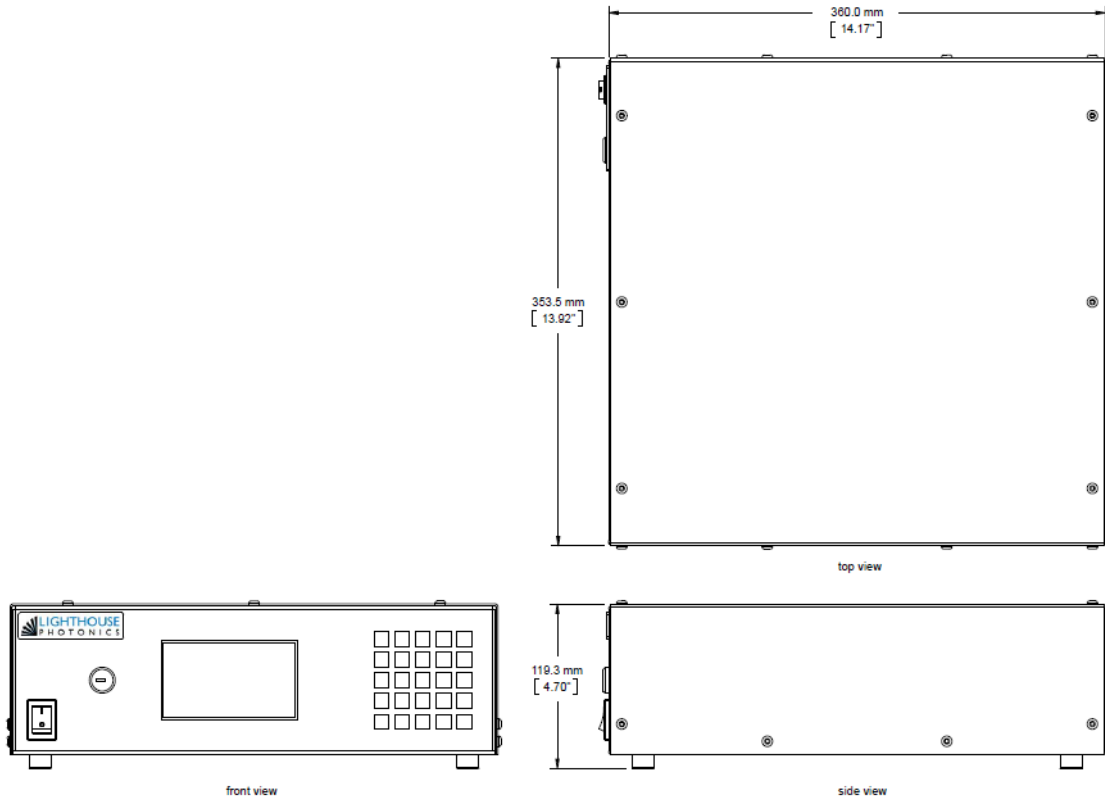

For more information go to: www.lighthousephotonics.com

Lighthouse Photonics Inc.
780 Montague Expy, Suite 304
San Jose, CA 95131 USA
phone: 408-708-7967
efax: 408-773-6240
e-mail: info@lighthousephotonics.com



Copyright © 2019 Lighthouse Photonics Inc. All rights reserved.
This product is covered by Lighthouse Photonics US patent # 9,008,144B2.
Sprout, Seal, LockT and NET are trademarks of Lighthouse Photonics Inc.